

尺寸圖 / Dimensions

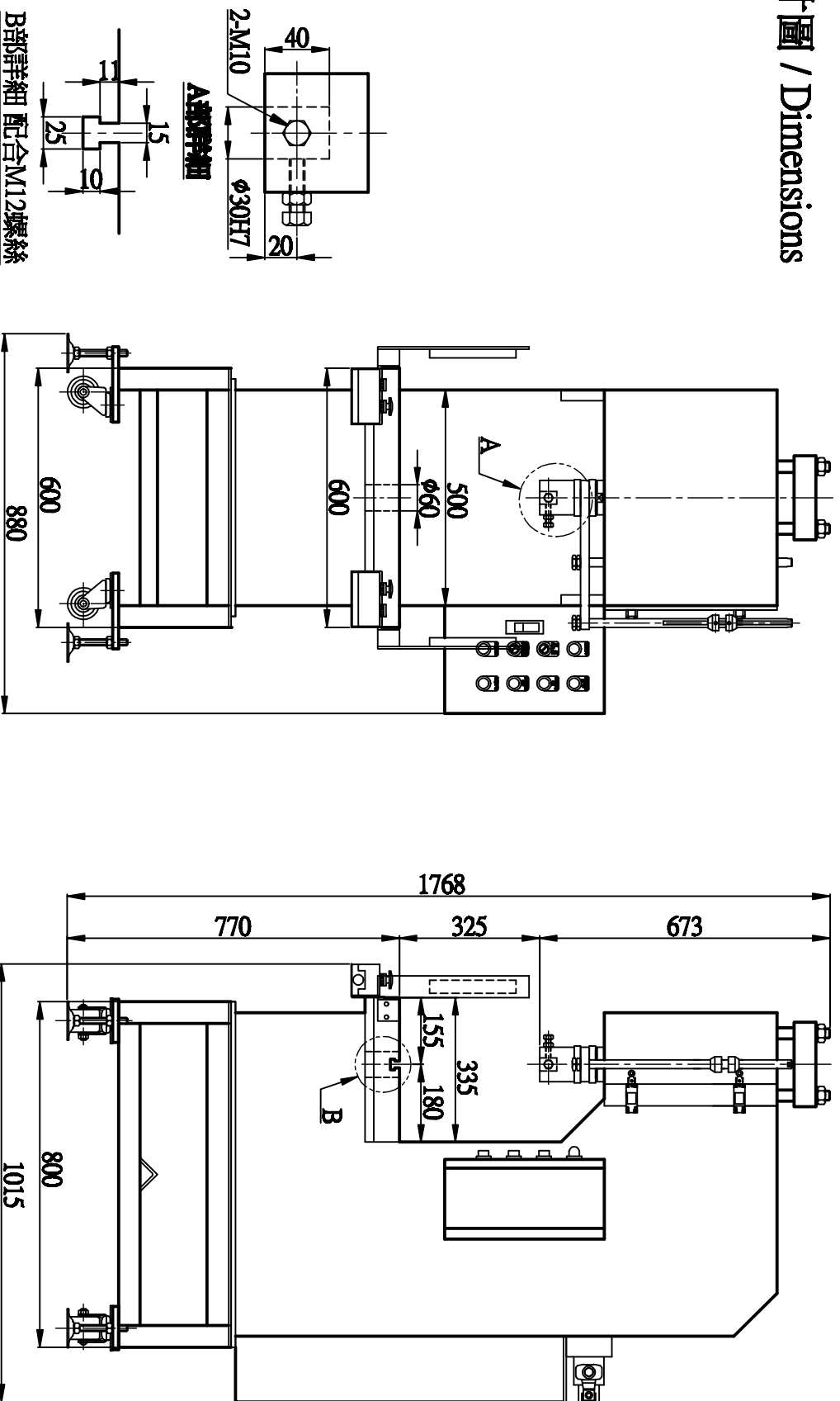

性能規格 / Specification

Model	Item		CYLINDER DIA. (mm)	DESCENDING SPEED (cm/min)	RISING SPEED (cm/min)	OPEN HEIGHT (mm)	WEIGHT (kg)	備註欄
	*OUTPUT (kg)	STROKE (mm)						
F106-20000-油壓壓床	20000	200	φ150	150	200	325	900	

*出力値之測定係在 120kgf/cm² 壓力表值條件下測得 / The output valve is measured at 120kgf/cm² shown on the pressure gauge.