

# 尺寸圖 / Dimensions

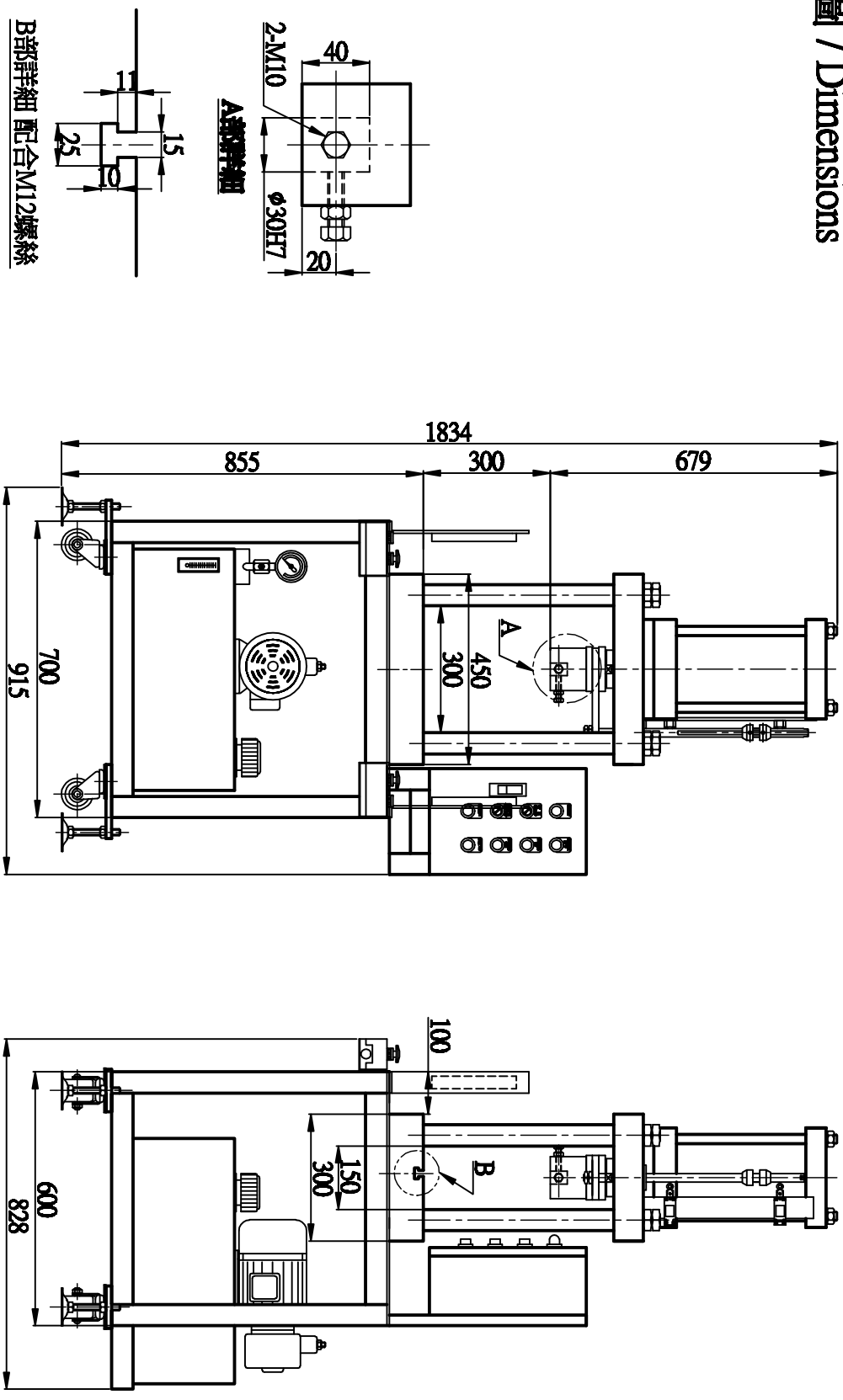

## 性能規格 / Specification

Model	Item		CYLINDER DIA. (mm)	DESCENDING SPEED (cm/min)	RISING SPEED (cm/min)	OPEN HEIGHT (mm)	WEIGHT (kg)	備註欄
	*OUTPUT (kg)	STROKE (mm)						
F107-30000-油壓壓床	30000	200	φ180	150	200	300	550	

\*出力値之測定係在 120kgf/cm<sup>2</sup> 壓力表值條件下測得 / The output valve is measured at 120kgf/cm<sup>2</sup> shown on the pressure gauge.