

尺寸圖 / Dimensions

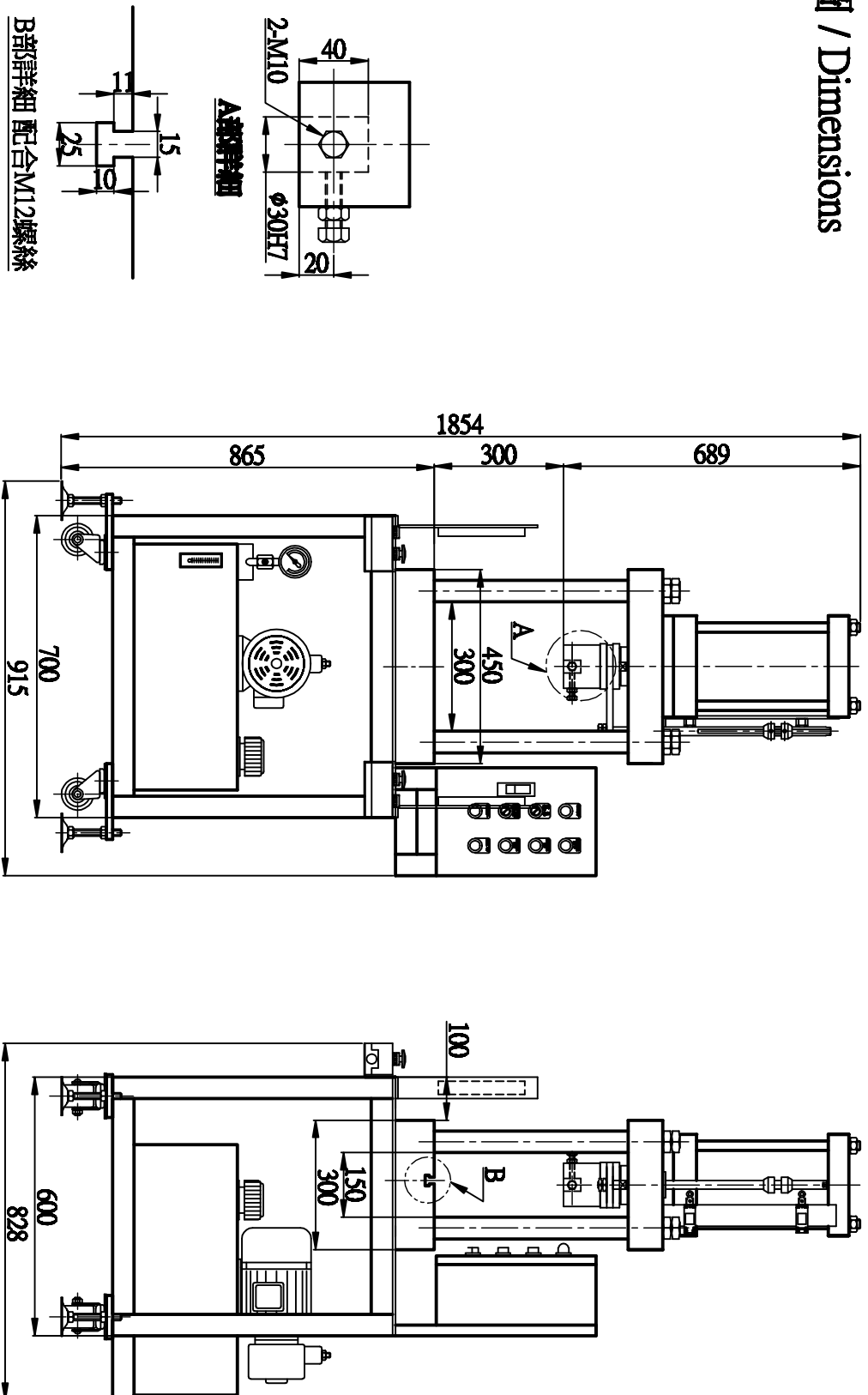

性能規格 / Specification

Model	Item		CYLINDER DIA. (mm)	DESCENDING SPEED (cm/min)	RISING SPEED (cm/min)	OPEN HEIGHT (mm)	WEIGHT (kg)	備註欄
	*OUTPUT (kg)	STROKE (mm)						
F107-40000-油壓壓床	40000	200	φ180	120	150	300	600	

*出力値之測定係在 160kgf/cm² 壓力表值條件下測得 / The output valve is measured at 160kgf/cm² shown on the pressure gauge.